

**FR** Annexe**ES** Apéndice**PT** Anexo**IT** Appendice**EL** Παράρτημα**PL** Załącznik**RU** Приложение**UK** Додаток**RO** Anexa**EN** Appendix

3276000232018	**QUAD201-W0-P	700x700 white	*DOP207758/0001/2015
3276000232025	**QUAD201-S0-C	700x700 silver	*DOP207758/0001/2015
3276000232032	**QUAD201-S0-P	700x700 silver	*DOP207758/0001/2015
3276005989054	**QUAD201-W1-C	800x800 white	*DOP207758/0001/2015
3276005717497	**QUAD201-W1	800x800 white	*DOP207758/0001/2015
3276005989092	**QUAD201-S1-C	800x800 silver	*DOP207758/0001/2015
3276005613027	**QUAD201-S1	800x800 silver	*DOP207758/0001/2015
3276005989139	**QUAD201-W2-C	900x900 white	*DOP207758/0001/2015
3276005717534	**QUAD201-W2	900x900 white	*DOP207758/0001/2015
3276005989177	**QUAD201-S2-C	900x900 silver	*DOP207758/0001/2015
3276005613065	**QUAD201-S2	900x900 silver	*DOP207758/0001/2015

SENSEA

QUAD

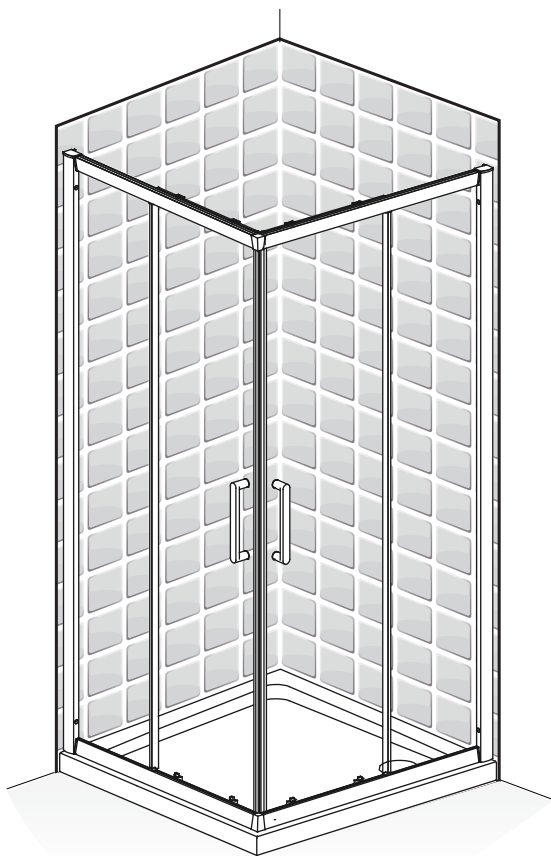

- FR** Notice de Montage, Utilisation, Entretien
- ES** Instrucciones de Montaje, Utilización y Mantenimiento
- PT** Instruções de Montagem, Utilização e Manutenção
- IT** Istruzioni per il Montaggio, l'Uso e la Manutenzione
- EL** Εγχειρίδιο συναρμολόγησης, χρήσης και συντήρησης
- PL** Instrukcja Montażu, Użytkowania i Konserwacji
- RU** Руководство По Сборке и Эксплуатации
- UK** Керівництво По Збірці і Експлуатації
- RO** Manual asamblare, utilizare și întreținere
- EN** Assembly - Use - Maintenance Manual



Traduction de la version originale du mode d'emploi / Traducción de las Instrucciones originales / Tradução das Instruções Originais / Traduzione delle istruzioni originali / Μετάφραση των πρωτότυπων οδηγιών / tłumaczenie instrukcji oryginalnej / Перевод оригинала инструкции / Переклад оригінальної інструкції / Traducerea instrucțiunilor originale / Original Instructions

2016/11

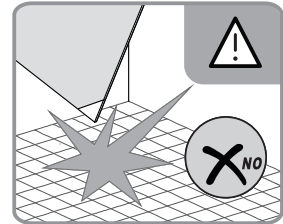
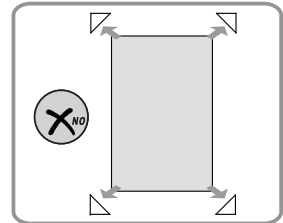
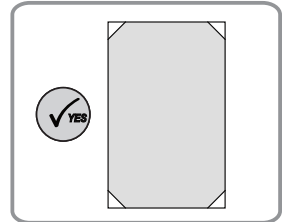
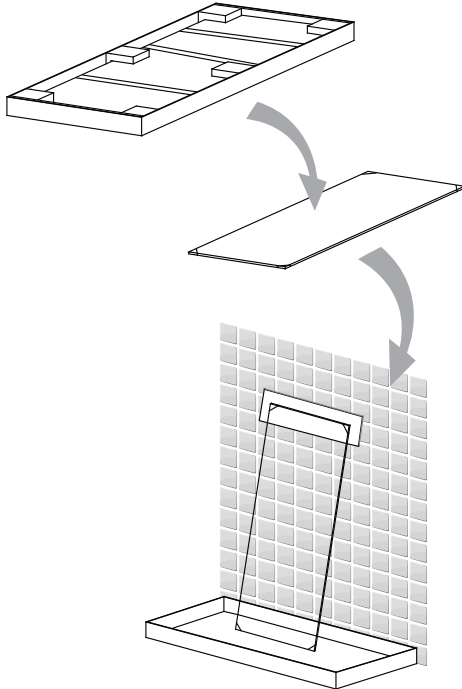
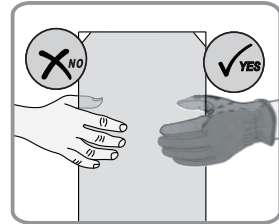
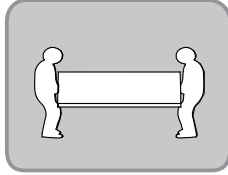
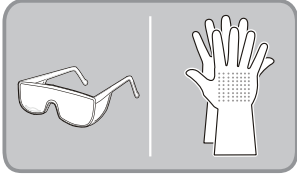
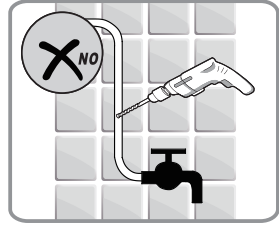
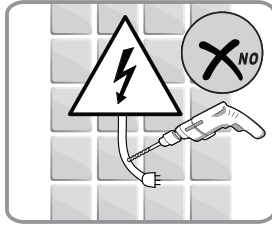
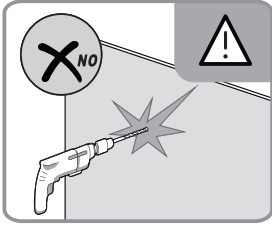

**FR** Vérifiez que les chevilles murales fournies sont appropriées à votre mur (celles fournies dans l'emballage sont conçues pour le béton). Sinon, utilisez des vis et des chevilles murales adaptées au type de matériau de votre mur. Pour obtenir des conseils concernant les vis et les chevilles appropriées à votre mur, demandez à un vendeur spécialisé.

**ES** Compruebe que todos los tacos suministrados puedan ser utilizados con su pared (los incluidos en la caja son para hormigón). En caso contrario, utilice tornillos y tacos de pared apropiados para el material de su pared. Para información acerca de las fijaciones y tornillos apropiados para su pared, consulte con un asistente de ventas especializado.

**PT** Certifique-se de que as buchas fornecidas são adequadas à sua parede (as fornecidas na embalagem são para betão). Caso contrário, use parafusos e buchas adequados ao tipo de material da sua parede. Para se aconselhar acerca dos parafusos e buchas adequados à sua parede, fale com um assistente de vendas especializado.

**IT** Verificare che i tasselli da parete forniti siano compatibili con la propria parete (quelli forniti con l'articolo sono per cemento). Altrimenti, utilizzare viti e tasselli adatti per la superficie della propria parete. Per ottenere consigli e suggerimenti sulle viti e i tasselli più adatti alla propria parete, consultare un rivenditore specializzato.

**EL** Βεβαιωθείτε ότι οι παρεχόμενες στερεώσεις τοίχου είναι κατάλληλες για τον τοίχο σας (οι παρεχόμενες στη συσκευή προορίζονται για μπετό). Αλλιώς χρησιμοποιήστε βίδες και στερεώσεις τοίχου κατάλληλες για τον τύπο υλικού του τοίχου σας. Για να λάβετε συμβουλές σχετικά με τις κατάλληλες βίδες και τα εξαρτήματα για τον τοίχο σας, ρωτήστε έναν ειδικό πωλητή.

**PL** Prosimy sprawdzić, czy dostarczone kolki do ścian nadają się do użycia w posiadanej ścianie (kolki dostarczone w zestawie są przeznaczone do betonu). Jeśli tak nie jest, należy użyć śrub i kołków odpowiednich do materiału, z którego wykonana jest ściana. Aby uzyskać poradę w sprawie śrub i elementów montażowych odpowiednich do danego typu ściany, należy zwrócić się z pytaniem do wyspecjalizowanego sprzedawcy.

**RU** Убедитесь, что прилагаемые дюбеля подходят для ваших стен (входящие в комплект дюбеля предназначены для бетона). В противном случае используйте шурупы и дюбеля, соответствующие материалу стены. Для получения рекомендаций по выбору шурупов и крепежных деталей, подходящих для вашей стены, обратитесь к специалисту-консультанту.

**UK** Перевірте, що анкери підходять для вашої стіни (ті, що постачаються в упаковці – для бетону). В іншому випадку використовуйте гвинти й стінові анкери, що відповідають матеріалу вашої стіни. Для отримання консультацій щодо гвинтів й фітінгів для вашої стіни зверніться до відповідного продавця-консультанта.

**RO** Verificați ca toate ancorele de perete furnizate să fie adecvate pentru peretele dumneavoastră (cele furnizate în pachet sunt pentru beton). În caz contrar, folosiți șuruburi și ancore de perete adecvate pentru tipul de material din care este peretele dumneavoastră. Pentru a obține recomandări privind șuruburile și armăturile adecvate pentru peretele dumneavoastră, întrebați un vânzător specializat.

**EN** Check that wall anchors provided are suitable for your wall (those provided in the package are for concrete). Otherwise, use screws and wall anchors suited to the type of material of your wall. To obtain advice on the screws and fittings suited to your wall, ask a specialized sales assistant.



**3M**

Assemble with this side, with easy clean treatment, on the inside.

İze karşi işleme tabi tutulmuş bu yüz iç tarafa doğru konulanmalıdır

Cette face, avec un traitement facilement nettoyable, doit être positionnée vers l'intérieur

Esta cara está tratada para facilitar su limpieza y se debe colocar hacia el interior

Esta face com tratamento para facilitar a limpeza, deve ficar voltada para o interior

Questo lato, deve essere posizionato con il trattamento easy clean all'interno.

Эта сторона, обработанная средством против образования накипи, должна быть обращена вовнутрь.

Сторона, оброблена засобом проти накипу, повинна бути звернена всередину.

Această față, tratată pentru curățare ușoară, trebuie poziționată spre interior

Strona z powłoką zapewniającą łatwe czyszczenie powinna być skierowana do wewnątrz.

Αυτή η όψη, με επεξεργασία για εύκολο καθαρισμό, πρέπει να τοποθετηθεί προς το εσωτερικό.



Attention danger / Atención: Peligro / Atenção perigo / Attenzione pericolo / Προσοχή κίνδυνος /  
Uwaga niebezpieczeństwo / Внимание! Опасно! / Увага! Небезпечно! / Atenție, pericol / Caution danger



Correct / Correcto / Correcto / Corretto / Σωστό / Dobrze / Правильный /  
Правильно / Corect / Correct



Incorrect / Incorrecto / Incorrecto / Errato / Λάθος / Źle / Неправильный /  
Неправильно / Incorect / Incorrect

**Notes / Observaciones / Notas / Note / Σημειώσεις / Notatki / Примечания / Примітки / Note / Notes**

---

---

---

---

---

---

---

---

**A**

FR Préparation

ES Preparación

PT Preparação

IT Preparazione

EL Προετοιμασία

PL Przygotowanie

RU Подготовка

UK Підготування

RO Pregătire

EN Preparation

2h

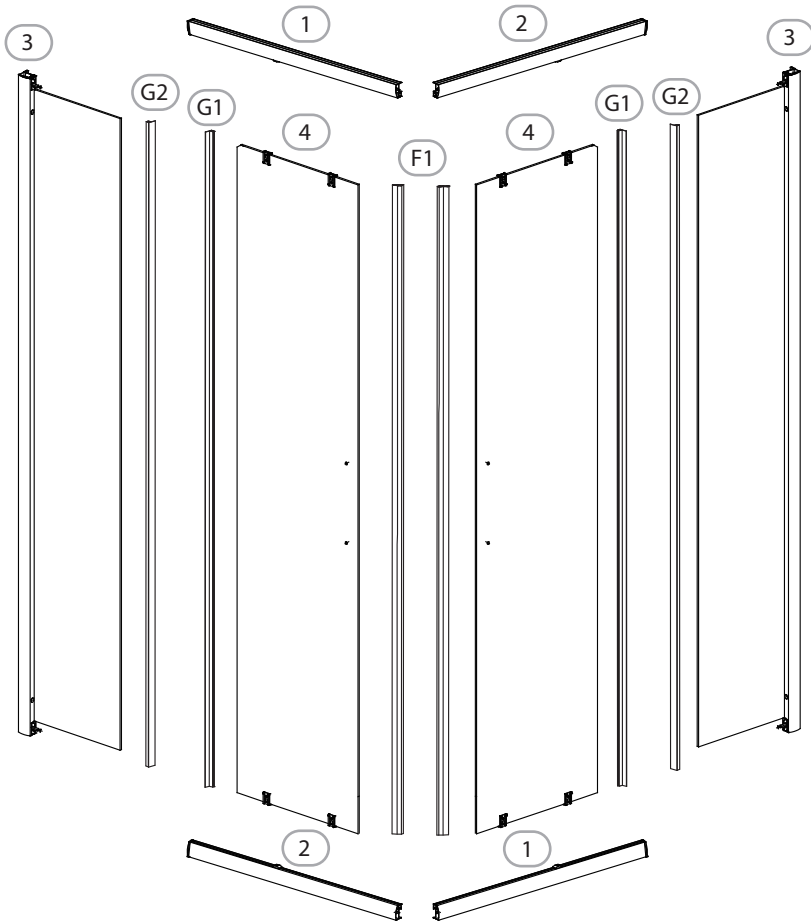
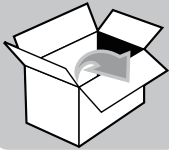

FR Préparation

ES Preparación

PT Preparação

IT Preparazione

EL Προετοιμασία

PL Przygotowanie

RU Подготовка

UK Підготування

RO Pregătire

EN Preparation

A

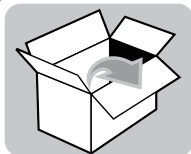

A1



x4

A2



x4

B1



x6

B2



x6

ST4x30mm

B3



x10

C1



x2

D1



x4

D2



x4

E1



x1

E2



x1

E3



x2

H1



x2

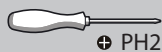
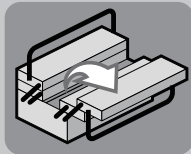

PH2



∅6mm

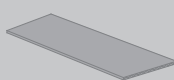
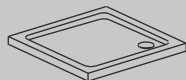
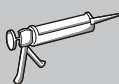
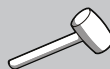
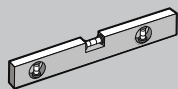

**B**

FR Montage

ES Montaje

PT Montagem

IT Montaggio

EL Συναρμολόγηση

PL Montaż

RU Сборка

UK Збірка

RO Montaj

EN Assembly

1

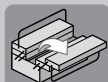
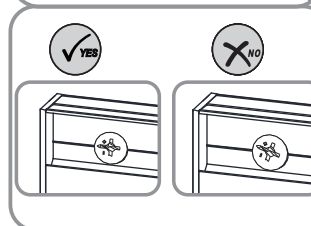
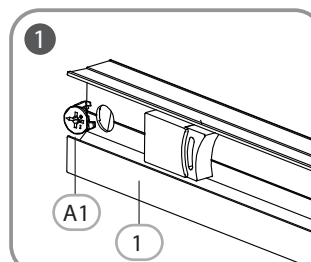
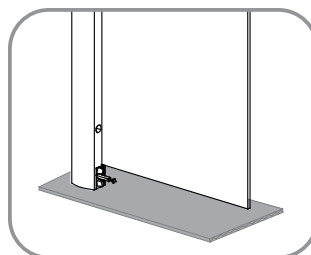
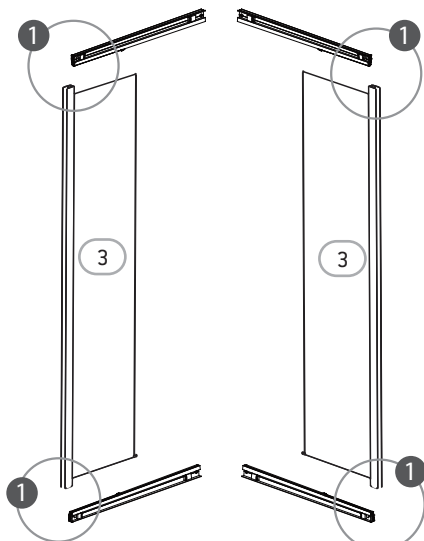
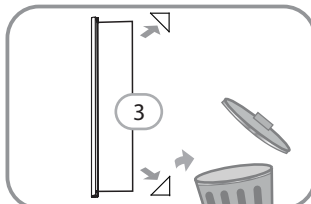
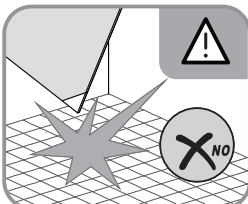

A1



x4

1

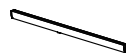

x2

3



x2

2



x2





FR Montage

ES Montaje

PT Montagem

IT Montaggio

EL Συναρμολόγηση

PL Montaż

RU Сборка

UK Збірка

RO Montaj

EN Assembly

B

2

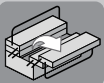
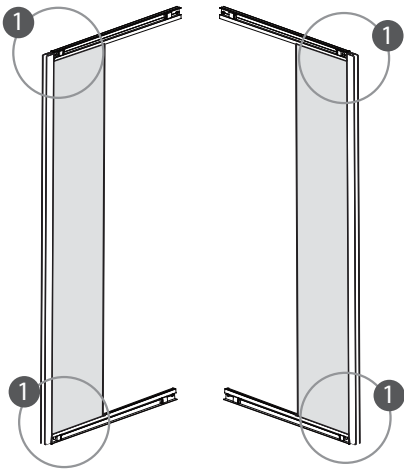
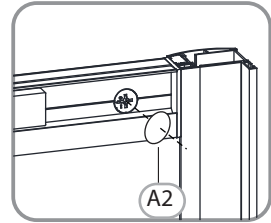
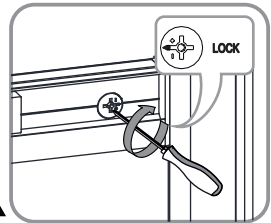
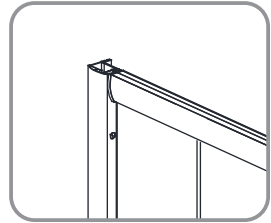
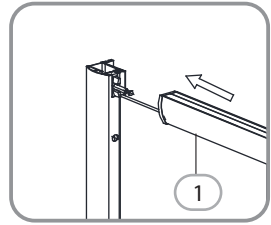
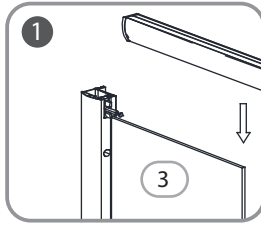

PH2

A2



x4



**B**

FR Montage

ES Montaje

PT Montagem

IT Montaggio

EL Συναρμολόγηση

PL Montaż

RU Сборка

UK Збірка

RO Montaj

EN Assembly

3

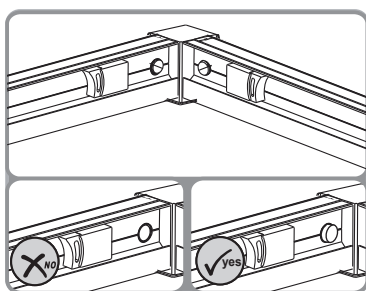
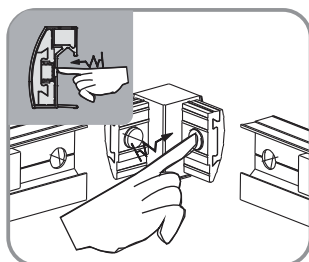
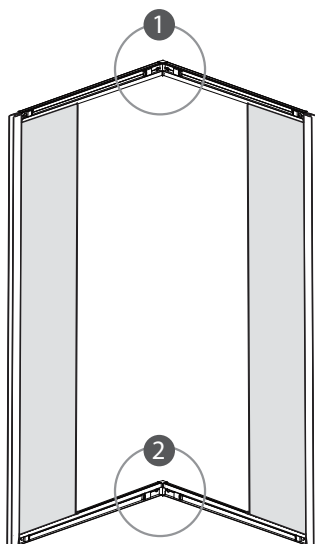
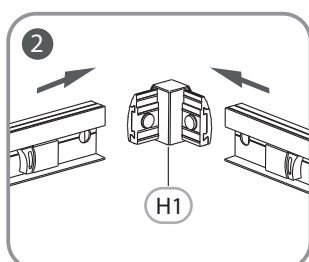
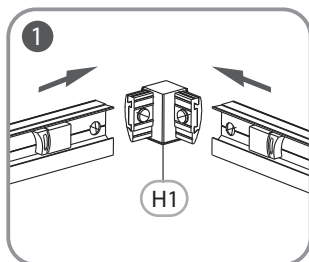

H1



x2



FR Montage

ES Montaje

PT Montagem

IT Montaggio

EL Συναρμολόγηση

PL Montaż

RU Сборка

UK Збірка

RO Montaj

EN Assembly

**B**

4

QUAD	X(mm)	Y(mm)
700x700mm	675 - 690	675 - 690
800x800mm	775 - 790	775 - 790
900x900mm	875 - 890	875 - 890

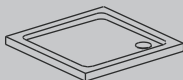
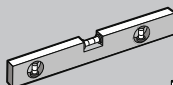
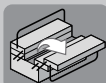
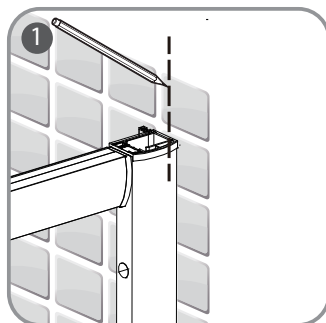

**B**

FR Montage

ES Montaje

PT Montagem

IT Montaggio

EL Συναρμολόγηση

PL Montaż

RU Сборка

UK Збірка

RO Montaj

EN Assembly

5

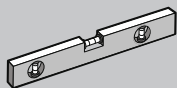
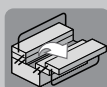
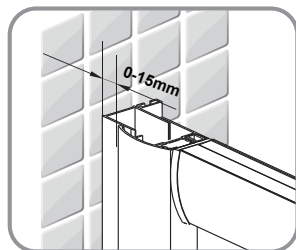
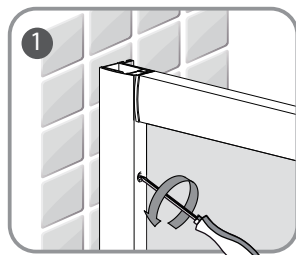
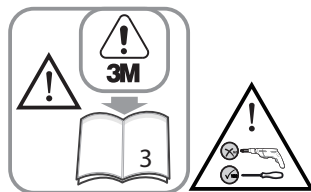
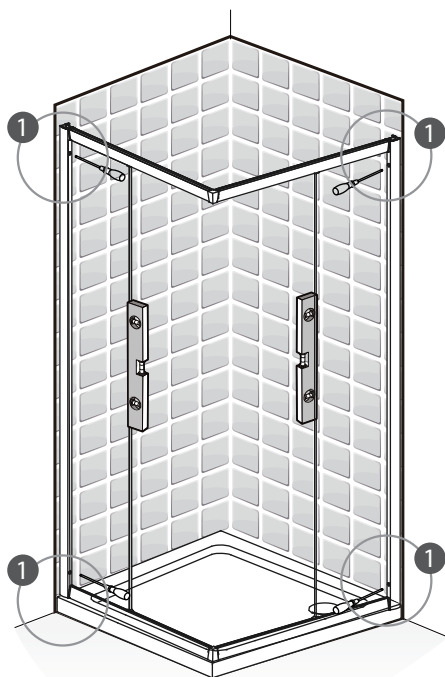

+ PH2

FR Montage

ES Montaje

PT Montagem

IT Montaggio

EL Συναρμολόγηση

PL Montaż

RU Сборка

UK Збірка

RO Montaj

EN Assembly

B

6

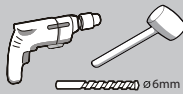
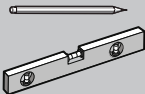
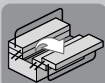
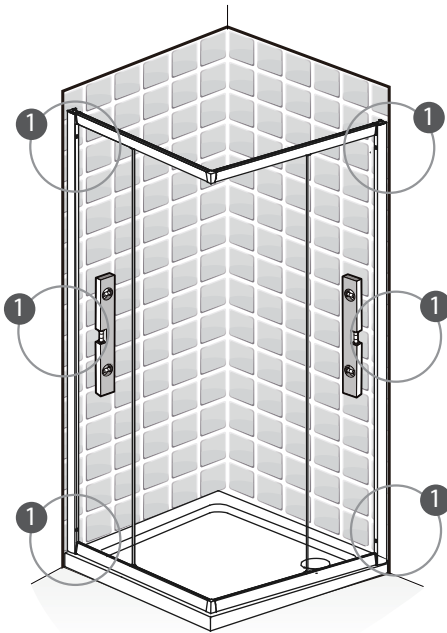
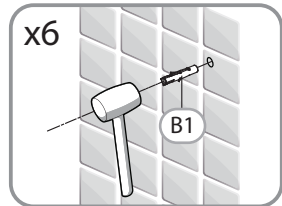
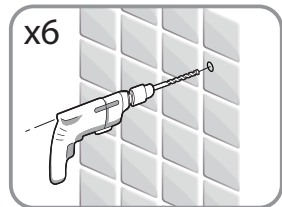
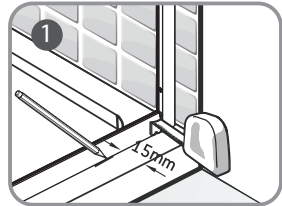
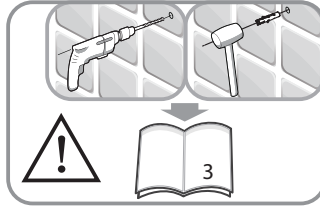

B1



x6



**B**

FR Montage

ES Montaje

PT Montagem

IT Montaggio

EL Συναρμολόγηση

PL Montaż

RU Сборка

UK Збірка

RO Montaj

EN Assembly

7

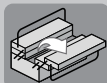
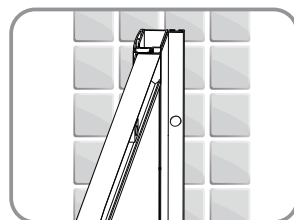
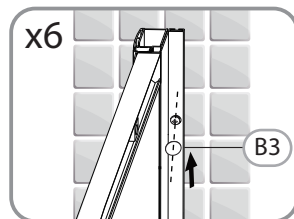
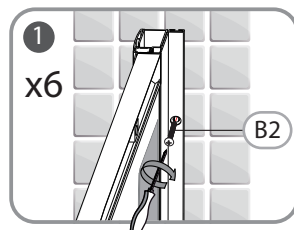
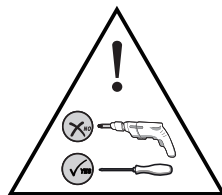
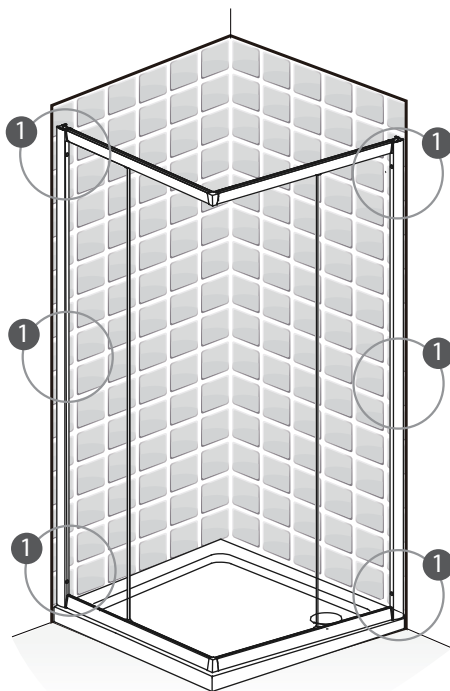
 PH2

B2



x6

ST4x30mm

B3



x6



FR Montage

ES Montaje

PT Montagem

IT Montaggio

EL Συναρμολόγηση

PL Montaż

RU Сборка

UK Збірка

RO Montaj

EN Assembly

B

8

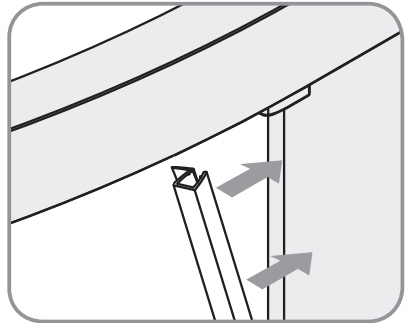
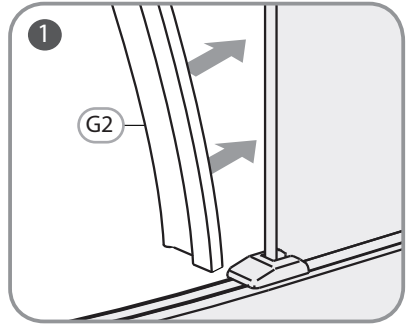
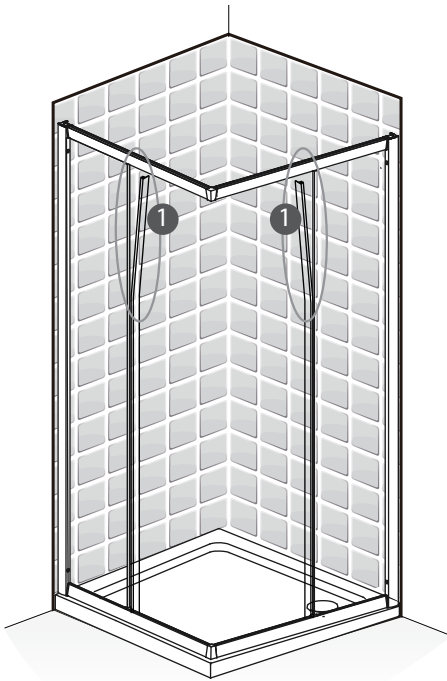

G2

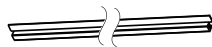

x2



**B**

FR Montage

ES Montaje

PT Montagem

IT Montaggio

EL Συναρμολόγηση

PL Montaż

RU Сборка

UK Збірка

RO Montaj

EN Assembly

9

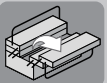
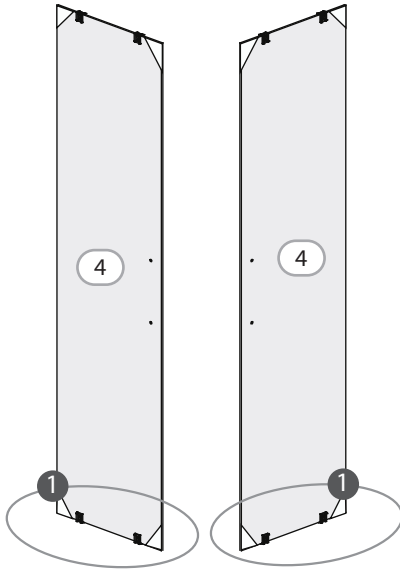
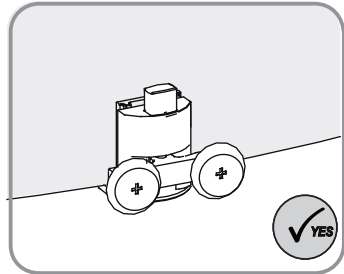
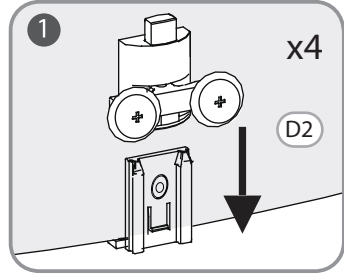
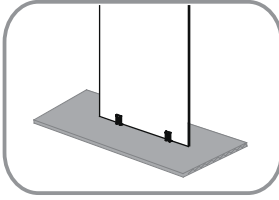
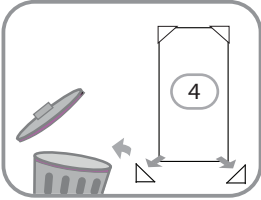
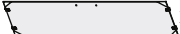
4  x2D2  x4



FR Montage

ES Montaje

PT Montagem

IT Montaggio

EL Συναρμολόγηση

PL Montaż

RU Сборка

UK Збірка

RO Montaj

EN Assembly

B

10

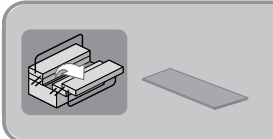
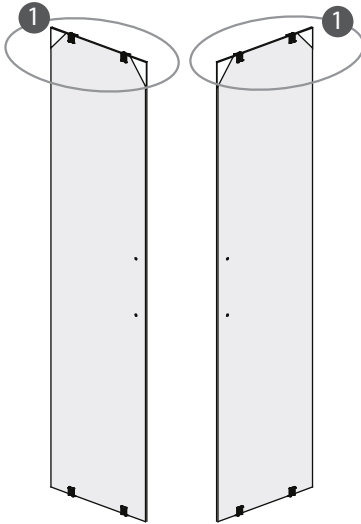
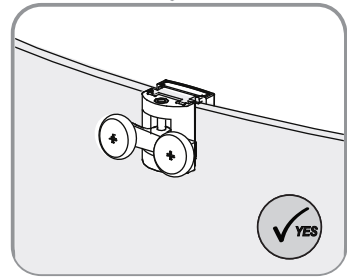
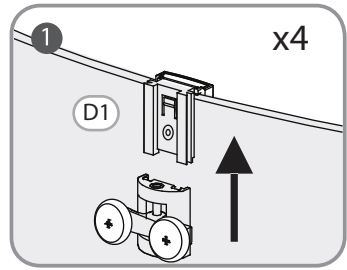
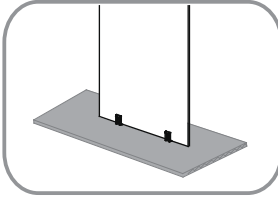
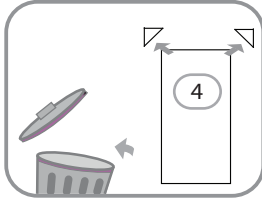

D1 x4



# B

FR Montage

ES Montaje

PT Montagem

IT Montaggio

EL Συναρμολόγηση

PL Montaż

RU Сборка

UK Збірка

RO Montaj

EN Assembly

11

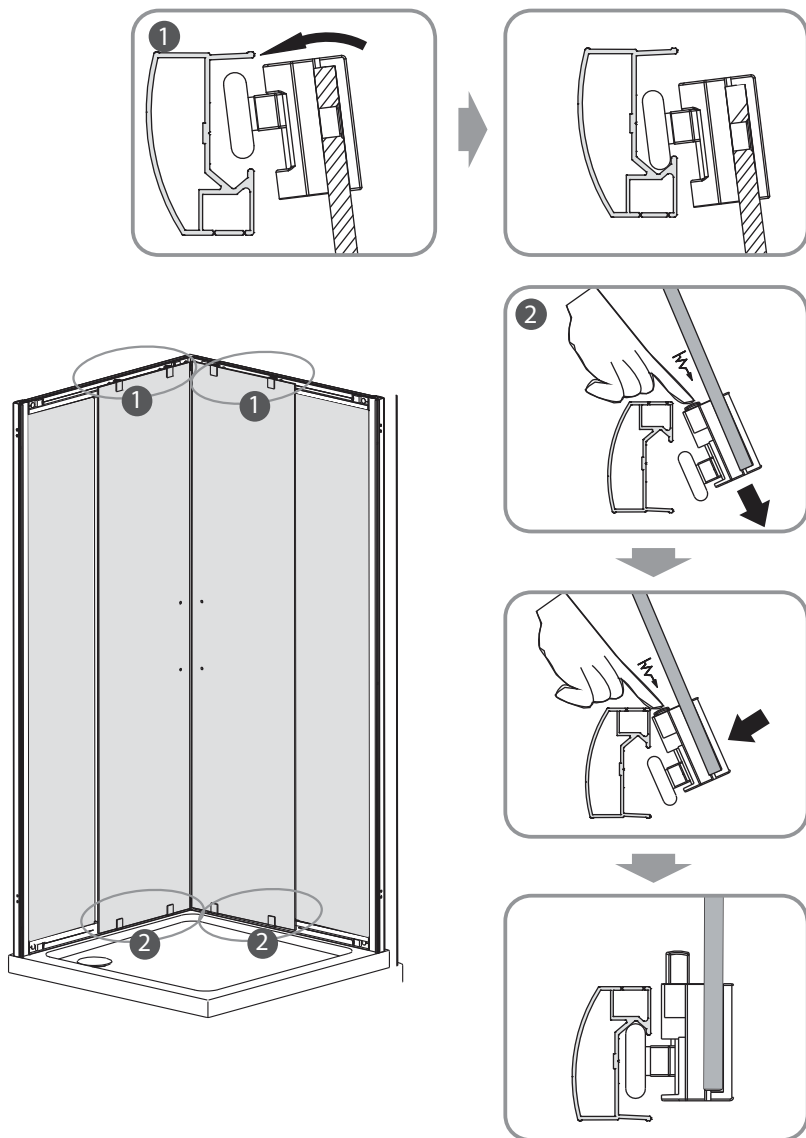

FR Montage

ES Montaje

PT Montagem

IT Montaggio

EL Συναρμολόγηση

PL Montaż

RU Сборка

UK Збірка

RO Montaj

EN Assembly

**B**

12

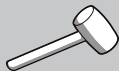
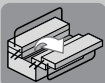
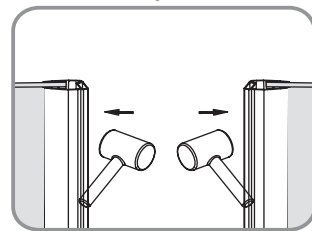
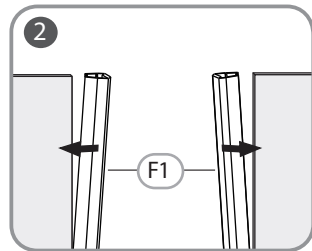
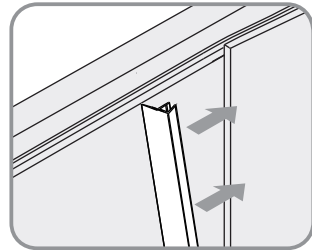
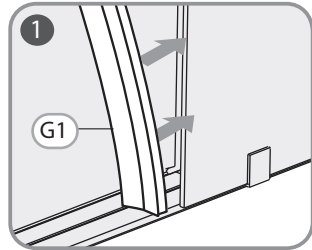
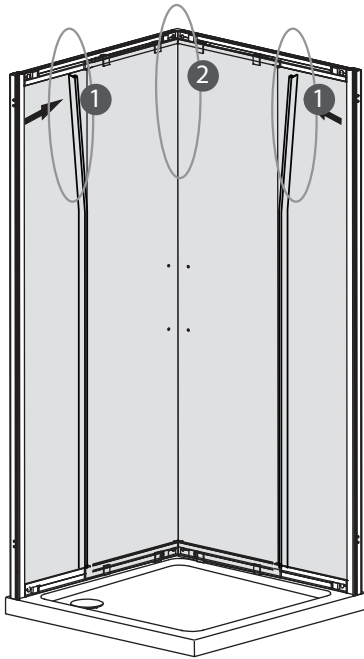

F1  x2

G1  x2



**B**

FR Montage

ES Montaje

PT Montagem

IT Montaggio

EL Συναρμολόγηση

PL Montaż

RU Сборка

UK Збірка

RO Montaj

EN Assembly

13

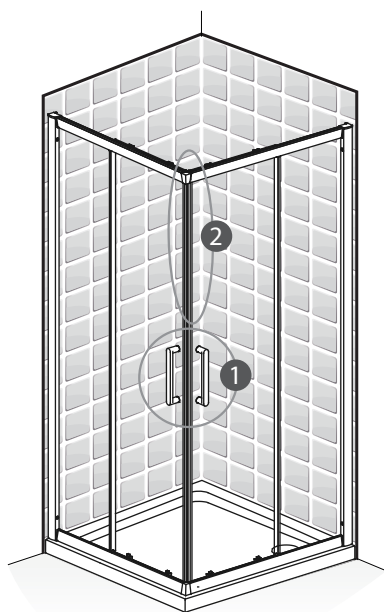
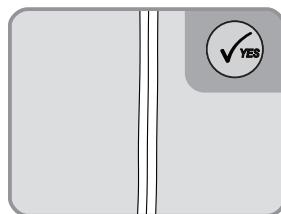
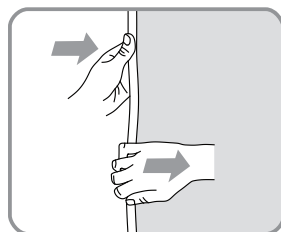
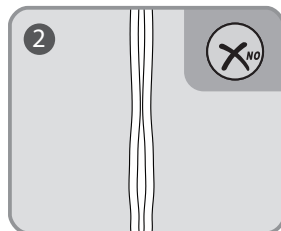
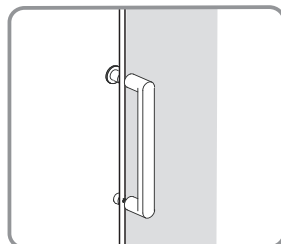
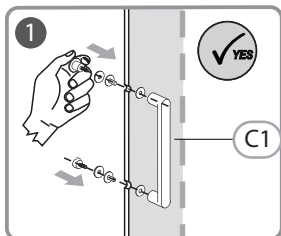

C1



x2



FR Montage

ES Montaje

PT Montagem

IT Montaggio

EL Συναρμολόγηση

PL Montaż

RU Сборка

UK Збірка

RO Montaj

EN Assembly

B

14

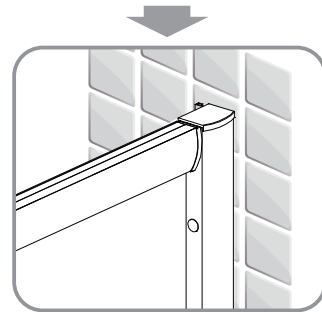
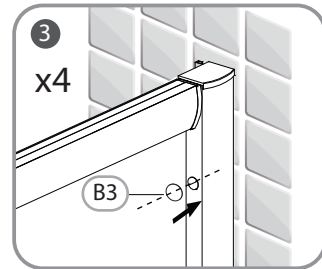
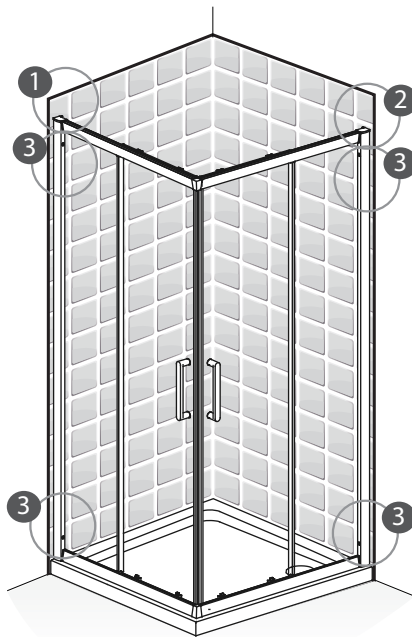
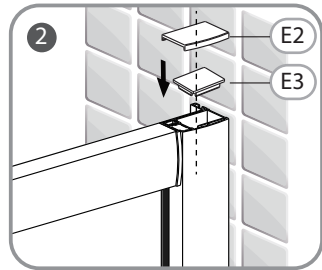
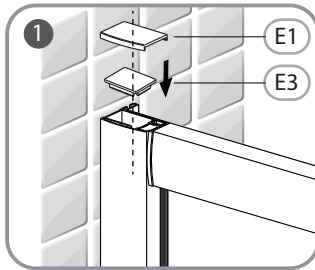

B3



x4

E1



x1

E2



x1

E3



x2



**B**

FR Montage

ES Montaje

PT Montagem

IT Montaggio

EL Συναρμολόγηση

PL Montaż

RU Сборка

UK Збірка

RO Montaj

EN Assembly

15

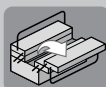
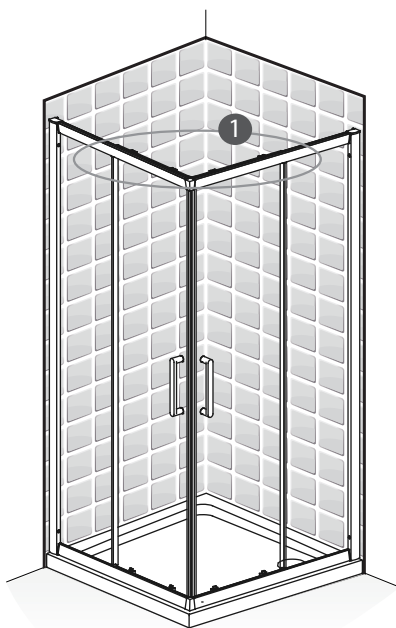
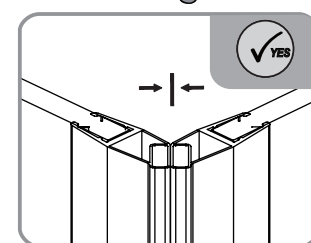
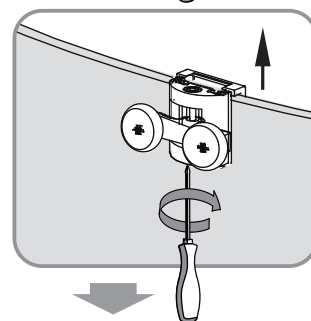
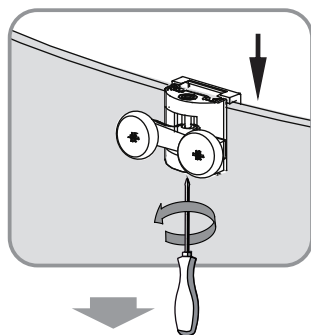
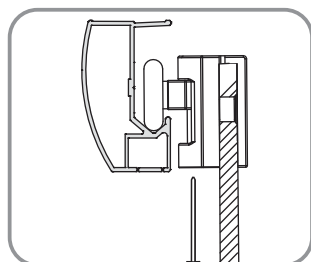
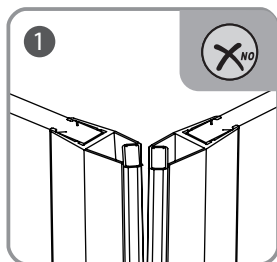
 PH2

FR Montage

ES Montaje

PT Montagem

IT Montaggio

EL Συναρμολόγηση

PL Montaż

RU Сборка

UK Збірка

RO Montaj

EN Assembly

B

16

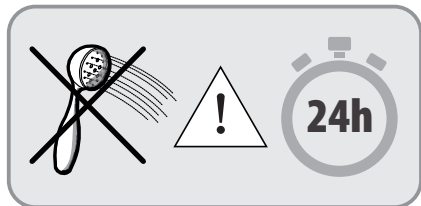
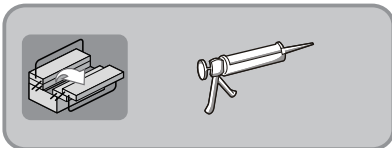
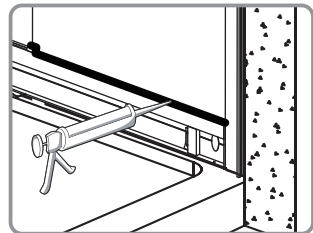
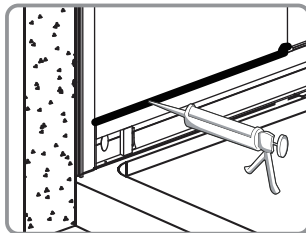
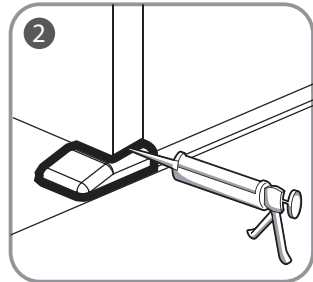
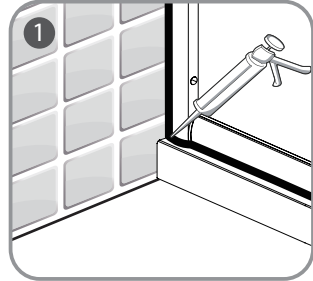
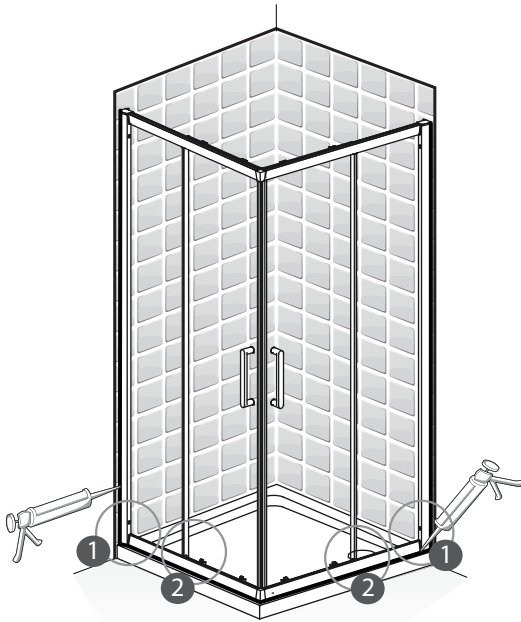

**C**

FR Entretien

EL Συντήρηση

RO Întreținere

ES Mantenimiento

PL Konserwacja

EN Maintenance

PT Serviço

RU Уход

IT Manutenzione

UK Догляд



Sans solvant / Sin disolvente / Sem solventes / Senza solventi / Χωρίς διαλυτικά / Bez rozpuszczalnika / Без растворителя / Без розчинника / Fără solvent / Solvent-free

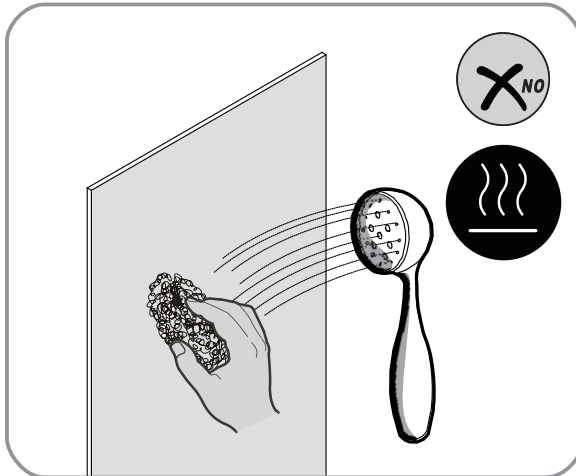
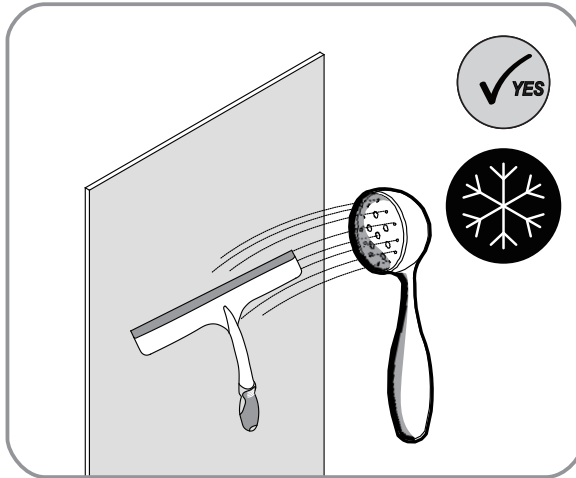



**FR**



ADEO Services -135 Rue Sadi Carnot -  
CS 00001 59790 RONCHIN - France  
16  
EN 14428:2015

Codice d'identificazione unico  
du produit type: \*\*  
usage prévu: hygiène personnelle  
Nettoyable: Conforme  
Résistance à l'impact/  
Capacité de Fragmentation: Conforme  
durabilité: Conforme

DOP N ° \*

**ES**



ADEO Services -135 Rue Sadi Carnot -  
CS 00001 59790 RONCHIN - France  
16  
EN 14428:2015

Código de identificación  
única del producto tipo: \*\*  
Uso previsto: higiene personal  
Limpiable: Conforme  
Resistencia al impacto/  
Capacidad de fragmentación: Conforme  
Durabilidad: Conforme

DOP N ° \*

**PT**



ADEO Services -135 Rue Sadi Carnot -  
CS 00001 59790 RONCHIN - France  
16  
EN 14428:2015

Código de identificação  
único do produto-tipo: \*\*  
Utilização prevista: higiene pessoal  
Limpeza: Conforme  
Resistência ao impacto/  
Capacidade de fragmentação: Conforme  
Durabilidade: Conforme

DOP N ° \*

**IT**



ADEO Services -135 Rue Sadi Carnot -  
CS 00001 59790 RONCHIN - France  
16  
EN 14428:2015

Codice di identificazione  
unico del prodotto-tipo: \*\*  
Uso previsto: igiene personale  
Pulibile: Conforme  
Resistenza agli urti/  
Capacità di Frammentazione: Conforme  
Durata: Conforme

DOP N ° \*

**EL**



ADEO Services -135 Rue Sadi Carnot -  
CS 00001 59790 RONCHIN - France  
16  
EN 14428:2015

Μοναδικός κωδικός ταυτοποίησης  
του τύπου του προϊόντος: \*\*  
προβλεπόμενη χρήση: προσωπική υγιεινή  
Δυνατότητα καθαρισμού: Σύμφωνα με  
Άντοχή σε κρούση/  
Ικανότητα κατάτμησης: Σύμφωνα με  
Διάρκεια: Σύμφωνα με

DOP N ° \*

**PL**



ADEO Services -135 Rue Sadi Carnot -  
CS 00001 59790 RONCHIN - France  
16  
EN 14428:2015

Niepowtarzalny kod  
identyfikacyjny typu wyrobu: \*\*  
przeznaczenie: higiena osobista  
Możliwość czyszczenia: Zgodny  
Odporność na uderzenia/  
Rozkruszalność: Zgodny  
Trwałość: Zgodny

DOP N ° \*

**RU**



ADEO Services -135 Rue Sadi Carnot -  
CS 00001 59790 RONCHIN - France  
16  
EN 14428:2015

Уникальный идентификационный  
код типа изделия: \*\*  
Назначение: личная гигиена  
Легкость очистки: Соответствие  
Ударопрочность/  
Мощность распыления: Соответствие  
Долговечность: Соответствие

DOP N ° \*

**UK**



ADEO Services -135 Rue Sadi Carnot -  
CS 00001 59790 RONCHIN - France  
16  
EN 14428:2015

Унікальний ідентифікаційний  
код виду продукції: \*\*  
призначення: особиста гігієна  
Легкість очищення: Відповідність  
Ударостійкість/  
Потужність розпилення: Відповідність  
Довговічність: Відповідність

DOP N ° \*

**RO**



ADEO Services -135 Rue Sadi Carnot -  
CS 00001 59790 RONCHIN - France  
16  
EN 14428:2015

Cod unic de identificare  
a tipului de produs: \*\*  
destinație: igienă personală  
Rezistență la impact/  
Capacitate de fragmentare: Conform  
Durabilitate: Conform

DOP N ° \*

**EN**



ADEO Services -135 Rue Sadi Carnot -  
CS 00001 59790 RONCHIN - France  
16  
EN 14428:2015

Unique identification code  
of the product-type: \*\*  
Intended use: personal hygiene  
cleanability: Pass  
Impact resistance/ shatter properties: Pass  
Durability: Pass

DOP N ° \*

\*\*

**FR** Reportez-vous à l'annexe.

**ES** Consulte el apéndice.

**PT** Consulte o anexo.

**IT** Consultare l'appendice.

**EL** Ανατρέξτε στο Παράρτημα.

**PL** Patrz załącznik.

**RU** См. приложение.

**UK** Читайте додаток.

**RO** Consultați anexa.

**EN** Refer to appendix.

ADEO Services  
135 Rue Sadi Carnot  
CS 00001  
59790 RONCHIN - France

ТОВ «Леруа Мерлен Україна»,  
вул. Полярна 17а, м. Київ  
04201, Україна

ООО ЛЕРУА МЕРЛЕН ВОСТОК,  
141031, Московская область,  
Мытищинский район, г. Мытищи,  
Осташковское шоссе, д.1, РОССИЯ

\* Garantie 3 ans / Garantía 3 años / Garantia 3 anos / Garanzia 3 anni  
Εγγύηση 3 ετών / Gwarancja 3 lat / 3 летняя / 3-річна гарантія  
3 ani garanție / Guarantee 3 years

Made In P. R.C. 2016